

# **ORAY**

## **PROFESSIONAL AND OFFICES**

———— 2024 Edition ————



### HOME CINEMA AND RESIDENTIAL

projection screens  
videoprojectors mounts  
flat screens mounts



### PROFESSIONAL AND OFFICES

projection screens  
videoprojectors mounts  
flat screens mounts



### STAGES AND EVENTS

projection screens  
cycloramas

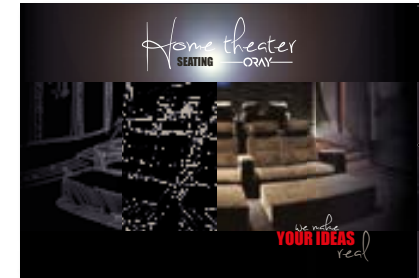

### HOME CINEMA SEATS

individual seats  
custom-made rows  
D-BOX Technology



# Our range of screens PROFESSIONAL and OFFICES

## ORAY COMPANY p 4

## ROLL-UP p 5

Squar'	p 6
Orion	p 8
Jumbo	p 9
Inceling Orion	p 10
GFO	p 11
Pantoscreen without casing	p 12
Pantoscreen with casing	p 13
Remote controls	p 14

## MANUALS p 15

Super Gear	p 16
Oray 2000	p 17

## NOMADS p 18

Butterfly mobile	p 19
Fly	p 20
Dragonfly, Cross Screen, Miniscreen	p 21
Style, Byron 2, Screen	p 22

## FRAMES p 23

Special video	p 24
Cinevision I	p 25
Cinevision II	p 26

## CUSTOM-MADE FABRICS p 27

Projection surfaces	p 28
Finishes	p 29

## MOUNTS p 30

<b>For video projectors</b>	
Motorised mounts	p 31
Fixed ceiling mounts	p 33
Fixed wall mounts	p 33
Outdoor housing	p 33
<b>For flat screens</b>	
Fixed mounts	p 34



This catalogue is printed on paper from responsible sources and from sustainably managed forests.



**FIRE RESISTANT CLASSIFICATION**  
Classification of the projection surface.



**ANY HEIGHT STOP**  
The screen can stop at several heights.



**SPEED SOLO SYSTEM**  
Easier and faster mounting by only one person.



**CUSTOMIZABLE**  
You can choose another projection surface or ask for a product adapted to your measurements.



**ADJUSTABLE HEIGHT**  
Adjusting the height of projection.



**PRINTING ON FABRIC**  
Possibility to personalise the fabric.



**ULTRA SHORT THROW**  
Model compatible with an Ultra Short Throw video projector



**MAXIMUM LOAD**



**CASING COLOR RAL**  
Other color maps on request, according to the references of RAL colour.



## QUALITY Know-how since 1947

The company ORAY, based south west of Paris, is dedicated to:

- The DESIGNING
- The MANUFACTURING
- The MARKETING

of projector screens and audiovisual accessories.

## TECHNOLOGY WATCH N°1 in France

The most exhaustive range  
Through continuous search of new products and the wish to adapt as closely as possible to the technical developments of projection, the company is the number 1 in France in the industry of projection screens and is one of the leaders worldwide.

## SUSTAINABLE DEVELOPMENT Eco-socio-conception

Social and environmental issues are a priority for ORAY. These commitments led the company to engage several actions in order to improve its global performance in a forward-looking business model:

- ECONOMICAL performance
- SOCIAL performance
- ENVIRONMENTAL performance

Keen to offer the best value for money on the whole range, ORAY takes special care of the choice of materials, the quality of the assembly and the innovative product designs.

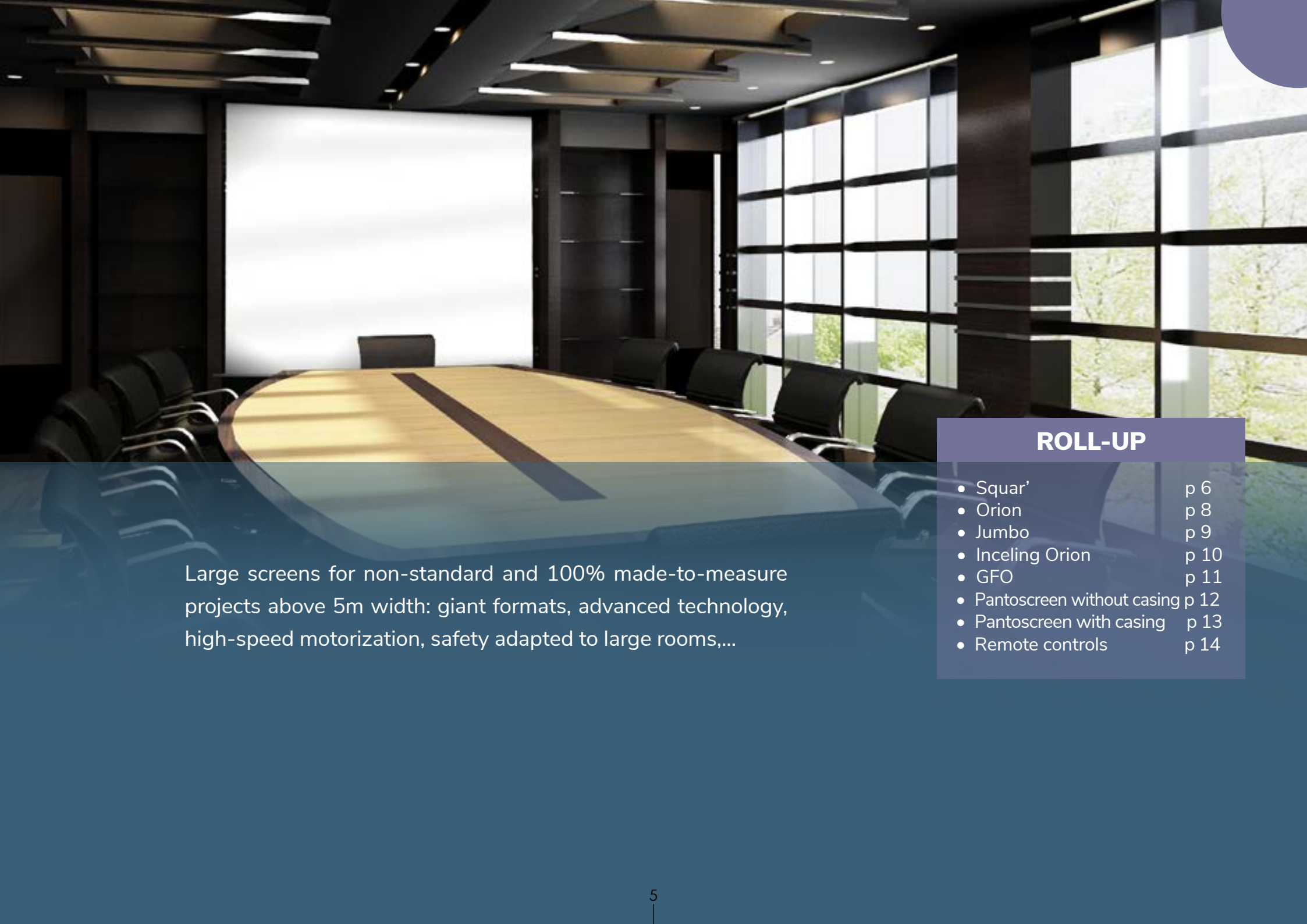

Large screens for non-standard and 100% made-to-measure projects above 5m width: giant formats, advanced technology, high-speed motorization, safety adapted to large rooms,...

## ROLL-UP

- Squar' p 6
- Orion p 8
- Jumbo p 9
- Inceling Orion p 10
- GFO p 11
- Pantoscreen without casing p 12
- Pantoscreen with casing p 13
- Remote controls p 14



# SQUAR'PRO

The **SQUAR'** is a very functional screen, ultra compact and simple to recess with its white lacquered aluminium case.

- The triangular weighing bar is perfectly integrated in the casing when the screen is rolled up.
- Wall or ceiling mounting.
- HC version with black frame available.



Triangular weighing bar

Wire switch included

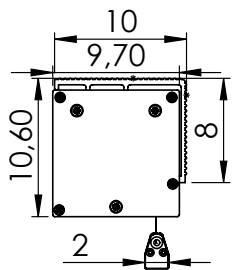

Casing profile  
Power supply on the right

## SQUAR' PRO



Image format Ht x Base (cm)	Matt white Reference	Casing Length (cm)
<b>16:10 format</b>		
112 x 180	SQ1B1112180	192,1
125 x 200	SQ1B1125200	212,1
150 x 240	SQ1B1150240	252,1
169 x 270	SQ1B1169270	282,1
187 x 300	SQ1B1187300	312,1
219 x 350	SQ1B4219350	362,1
<b>4:3 format</b>		
135 x 180	SQ1B1135180	192,1
150 x 200	SQ1B1150200	212,1
180 x 240	SQ1B1180240	252,1
202 x 270	SQ1B1202270	282,1
225 x 300	SQ1B1225300	312,1
<b>1:1 format</b>		
150 x 150	SQ1B1150150	162,1
180 x 180	SQ1B1180180	192,1
200 x 200	SQ1B1200200	212,1
240 x 240	SQ1B1240240	252,1
300 x 300	SQ1B1300300	312,1



Remote controls  
optional p14



- FALSE-CEILING INTEGRATION
- ULTRA COMPACT

# Accessories for SQUAR'

The **UNDERFACE +** for SQUAR' screens is easy to install and aesthetic:

It offers a 2 in 1 solution for the integration of your screen in a false ceiling.



Closed system



Underface +



False-ceiling mounting set for underface +  
1m threaded rods and fixing brackets

The **STAND-OFF BRACKETS** can space the screen from the wall. Must be used without an underface.



Stand-off brackets, for wall offset.  
One pair up to 300 cm base.  
A trio for model 350 cm base.

## 2 POSSIBILITIES FOR INSTALLATION:

### 1 One shot installation:

- Installation of the screen at the same time of the underface.

### 2 Installation in two phases:

- installation of the underface + during false ceiling construction.
- installation of the screen in the underface+ when works are finished.

### UNDERFACE +



Screen base (cm)	Reference
150	SQ4150
180	SQ4180
200	SQ4200
240	SQ4240
270	SQ4270
300	SQ4300
350	SQ4350

### FALSE-CEILING KIT

1 kit for one underface	Reference
Up to 3m base	OPTKITFIX01
for SQ4350	OPTKITFIX02

### STAND-OFF BRACKETS



The pair	Reference
10 cm	OPTECAR10BSQ
20 cm	OPTECAR20BSQ
The trio	Reference
10 cm	OPTECAR10BSQ3
20 cm	OPTECAR20BSQ3



- VERY SIMPLE INTEGRATION

# ORION PRO

The top of the range motorised screen, **ORION**, ensures its user reliability, aesthetics and uncompromising integration.

This product has been designed for easy installation, whatever the constraints, thanks to the Speed Solo system. It has a protective housing with no visible screw. The tensioned version is the only possible compromise for ultrashort-throw projection if a fixed frame screen is not possible.



- White lacquered aluminium casing, other colours on request.
- Possibility of customising by printing all or part of the surface of the screen (logo, visual, texts...)
- Wire switch included
- **TENSIONED version:** lateral cables allow the tensioned projection surface to remain flat regardless of the screen's environment.
- HC version with black borders can be produced



## ORION PRO Matt white



Image (cm)	Reference	Section	Casing length (cm)
<b>16:10 format</b>			
125 x 200	OR1B1125200	Small Casing	216
150 x 240	OR1B1150240	Small Casing	256
169 x 270	OR1B1169270	Small Casing	286
187 x 300	OR1B1187300	Small Casing	316
219 x 350	OR1B1219350	Large Casing	366
250 x 400	OR1B1250400	Large Casing	417
312 x 500	OR1B1312500	Large Casing	517

### 4:3 format

135 x 180	OR1B1135180	Small Casing	196
150 x 200	OR1B1150200	Small Casing	216
180 x 240	OR1B1180240	Small Casing	256
202 x 270	OR1B1202270	Small Casing	286
225 x 300	OR1B1225300	Small Casing	316
263 x 350	OR1B1263350	Large Casing	366
300 x 400	OR1B1300400	Large Casing	417
375 x 500	OR1B1375500	Large Casing	517

### 1:1 format

180 x 180	OR1B1180180	Small Casing	196
200 x 200	OR1B1200200	Small Casing	216
240 x 240	OR1B1240240	Small Casing	256
270 x 270	OR1B1270270	Small Casing	286
300 x 300	OR1B1300300	Small Casing	316
350 x 350	OR1B1350350	Large Casing	366
400 x 400	OR1B1400400	Large Casing	416



Stand-off bracket of 10 or 20 cm for a screen base < 4 m and up to 30 cm for a screen base < 3 m



30 cm offset for screens of 4 m and more, 10 to 40 cm for screens = 5 m, 40 cm for all sizes

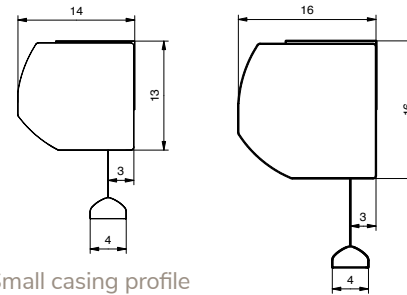

Small casing profile Power supply on the right Large casing profile



Motor cut-off security device when closing

## STAND-OFF BRACKETS by pair or trio depending on the length of the casing

Screen base < 3 m	The pair	3m ≥ screen < 5m	The trio	Screen = 5 m	The trio
Reference	Offset	Reference	Offset	Reference	Offset
OPTECAR10GOR2	10 cm	OPTECAR10GOR3	10 cm	OPTECAR10GOR5	10 cm
OPTECAR20GOR2	20 cm	OPTECAR20GOR3	20 cm	OPTECAR20GOR5	20 cm
OPTECAR30GOR2	30 cm	OPTECAR30GOR3	30 cm	OPTECAR30GOR5	30 cm
OPTECAR40GOR2	40 cm	OPTECAR40GOR3	40 cm	OPTECAR40GOR5	40 cm



Remote controls optional p14



Optional



- MOTOR CUT-OFF SECURITY
- CASE WITHOUT VISIBLE SCREW



# JUMBO PRO

The **ORION JUMBO** is a high-end motorised screen. Its square-section housing allows easy integration. Easy to hang from two points at each end of the housing.

The tensioned version is the only possible compromise for ultra-short-throw projection if a fixed frame screen is not possible.

**JUMBO accessories** allow several fixing methods:

- Ceiling mounting
- Wall mounting (optional)
- Barrel mounting (optional)
- Wire switch included
- **TENSIONED version**

The lateral cables allow the tensioned projection surface to remain flat regardless of the screen's environment.

- **HC version** with black borders can be produced

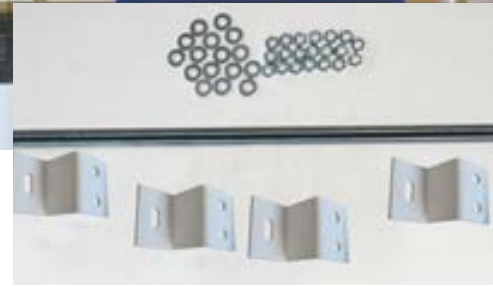

Easy to integrate square case

OPTION: Suspended mounting set  
1m threaded rods and fixing brackets

OPTION: Barrel mounting

## JUMBO PRO Matt white



Image (cm)	Reference	Casing length (cm)
<b>16:10 format</b>		
150 x 240	JU1B1150240	256
169 x 270	JU1B1169270	286
187 x 300	JU1B1187300	316
219 x 350	JU1B1219350	366
250 x 400	JU1B1250400	417
312 x 500	JU1B1312500	517
<b>4:3 format</b>		
180 x 240	JU1B1180240	256
202 x 270	JU1B1202270	286
225 x 300	JU1B1225300	316
263 x 350	JU1B1263350	366
300 x 400	JU1B1300400	417
375 x 500	JU1B1375500	517
<b>1:1 format</b>		
240 x 240	JU1B1240240	256
270 x 270	JU1B1270270	286
300 x 300	JU1B1300300	316
400 x 400	JU1B1400400	416

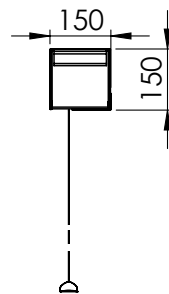

Casing profile  
Power supply on the right

## SUSPENDED MOUNTING

Reference	Unit
OPTKITOP2	1 kit

## WALL MOUNTING

Reference	Unit
PATMURJUM15	The pair

## STAND-OFF BRACKETS

The pair	
Reference	Offset
OPTECAR10JU	10 cm
OPTECAR20JU	20 cm
OPTECAR30JU	30 cm
OPTECAR40JU	40 cm

## BARREL MOUNTING

Reference	Unit
PATPERJUM01	The pair



Remote controls  
optional p14



Optional



- **MOTOR CUT-OFF SECURITY**
- **EASY TO INTEGRATE**

# IN-CEILING ORION PRO

The **IN-CEILING ORION** is a all-in-one solution for an easy and aesthetic recessed installation. Easy installation, especially designed to fit any false ceiling.

- **TENSIONED version**  
The lateral cables allow the tensioned projection surface to remain flat regardless of the screen's environment.
- **HC version** with black borders can be produced

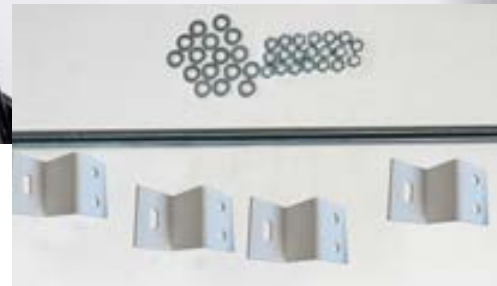

## IN-CEILING ORION PRO



The weighing bar closes the whole case in raised position

OPTION: mounting set  
1m threaded rods and fixing brackets

Wire switch included

Image (cm)	Matt white Ref.	Casing length (cm)
<b>16:10 format</b>		
150 x 240	OP1B1150240	256
169 x 270	OP1B1169270	286
187 x 300	OP1B1187300	316
219 x 350	OP1B1219350	366
250 x 400	OP1B1250400	417
312 x 500	OP1B1312500	517
<b>4:3 format</b>		
180 x 240	OP1B1180240	256
202 x 270	OP1B1202270	286
225 x 300	OP1B1225300	316
263 x 350	OP1B1263350	366
300 x 400	OP1B1300400	417
375 x 500	OP1B1375500	517
<b>1:1 format</b>		
240 x 240	OP1B1240240	256
270 x 270	OP1B1270270	286
300 x 300	OP1B1300300	316
400 x 400	OP1B1400400	416

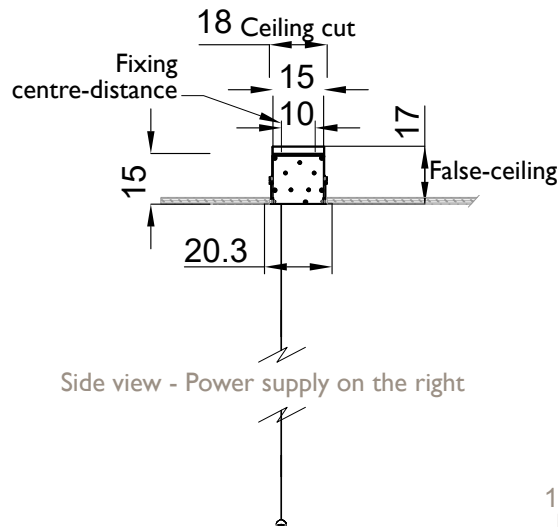

## MOUNTING KIT

Base	Reference
screen < 300 cm	OPTKITOP2
screen ≥ 300 cm	OPTKITOP3



Remote controls optional p14



Optional



- **INVISIBLE WHEN ROLLED UP**

# GFO

The **GFO** screens are the natural complement of Orion screens to equip high capacity conference rooms.

The GFO is easy to install and very compact.

The overall length of its housing is only 16,5 cm more than the image format.



Shanghai Tower

- Casing with white epoxy finish.
- Screen fitted with the patented roller counterbalance mechanism to prevent bending.
- Safety brake certified DIN-EN-13241
- Motor power: 350 W
- Diameter of the mechanism : 15 cm
- Weighing bar diameter: 3.4 cm
- Ceiling mount in standard
- Can be recessed in ceiling with under-face option
- Up to 8 m base



OPTION Underface for embedding



OPTION Barrel mount.  
Reference (The pair) PATPERGFO



OPTION  
Wall mount with or without offset



SUPPLIED AS STANDARD Ceiling mount

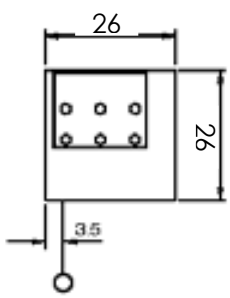

26x26 casing profile  
up to 7m base  
Power supply on the right

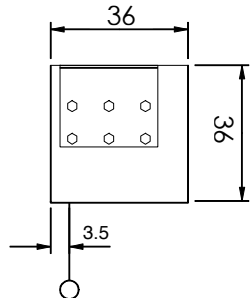

36x36 casing profile  
between 7m and 8m base  
Power supply on the right



Quote on request according to your specs



Remote controls  
optional



- EASY INSTALLATION
- COMPACT
- ANTI-BENDING SYSTEM

# PANTOSCREEN WITHOUT CASING

The **PANTOSCREEN WITHOUT CASING** is a recessable electric screen, equipped with a tensioning system at the back, invisible during the projection. It is the solution for a perfect integration in a media furniture, scene,...

- Motorised ascending screen
- The horizontal top bar of the screen can support an additional 500g per metre and is equipped with a mechanism for levelling the screen surface.
- Power supply on the right side.
- An HC version with black borders can be produced

Requires sturdy mounting to prevent tipping



Pantoscreen without casing



Upper bar



Wire switch included

**PANTOSCREEN WITHOUT CASING PRO**  
Black out Matt white fabric.  
Full width image.



**PANTOSCREEN WITHOUT CASING TENSIONED**  
Black out Matt white fabric.  
Full width image.



Tensioning system at the back





 Remote controls optional p14  

 Optional



- WITHOUT CASING
- INVISIBLE TENSIONING SYSTEM AT THE BACK



# PANTOSCREEN WITH CASING

The **PANTOSCREEN WITH CASING** screen is equipped with a housing and a pantograph mechanism at the back. White aluminium casing as standard. Motorised ascending screen.



- **Footless Pantoscreen:** requires a robust fixing to prevent tipping.
- **Pantoscreen with feet:** in option.
- An HC version with black borders can be produced

Never open the screen unless it is firmly attached to its stand or its feet



Casing



## OPTION ON FEET

Screen that opens from the bottom to the top, with a supporting structure equipped with 4 wheels, for places where it is impossible to fix a screen.



Wire switch included

## PANTOSCREEN WITH CASING PRO

Black out Matt white fabric.  
Full width image.



## PANTOSCREEN WITH CASING TENSIONED

Black out Matt white fabric.



Invisible tensioning system at the back



Remote controls optional p14



Optional



- **INVISIBLE TENSIONING SYSTEM AT THE BACK**
- **NOMADIC: ON FEET**



# REMOTE CONTROLS

**INFRARED**



Ref. OPTCOMIRHOME1

Infrared receiver + infrared remote control.

**KEY SWITCH**



Ref. OPTINTERCLE

Momentary position Key switch. Can be associated to a wired inverter.



Réf : 6AMP0737

Fixed position key switch. Cannot be associated to another inverter.

**RADIO TRIGGER**



Ref. OPTCOMTRIG1

Radio TRIGGER Open the screen when switching on the videoprojector. Compatible with videoprojector equipped with IEC C13 cable.

**RADIO ORAY**



Ref. OPTCOMMANDRAD8

Radio receiver + remote control  
The receiver has a free terminal block for dry contacts.



Ref. 1MOT03083

1 channel remote



Ref. 1MOT03084

6 channels remote



Ref. OPTCOMMANDRAD9

Radio receiver + HF wall switch.  
Additional HF wall switch.  
1MOT03085



Ref. 1MOT03086

Wired wall transmitter integrating a radio receiver function.

**RADIO SOMFY**



Ref. OPTCOMMANDRAD3

Radio receiver + remote control



Ref. OPTCOMMANDRAD4

Radio receiver + HF wall switch



Ref. 1MOT03041

Receiver only



Ref. 1MOT03016

Wall-mounted switch to be associated with a radio receiver.



Ref. 1MOT03011

Portable transmitter to be associated with a radio receiver.



Ref. : 1MOT03013

4-channel transmitter to control up to 4 devices to be associated with a radio receiver.



Crédit Photo ORAY

With these screens you will find an economical solution of quality for all your projections up to 2m40. They can be attached to the wall or the ceiling. Some optional fasteners will allow you to shift your screen from the wall.

## MANUALS

- Super Gear p 16
- Oray 2000 p 17

# SUPER GEAR

The **SUPER GEAR** screen is equipped with an aluminum case which design is very modern.

Photo credit: Nicolas Plessis  
Interview Production

- M1 fire-resistant matt white projection surface for the PRO range.
- New SRS (Slow return system) stopping device which controls the progressive rising up of the weighing bar.



Case with white epoxy finish

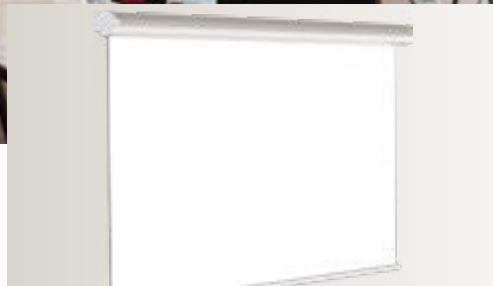

Super Gear PRO

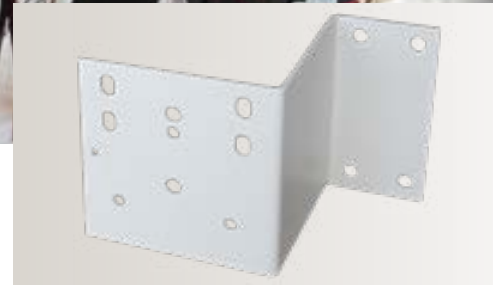

OPTION Stand-off brackets

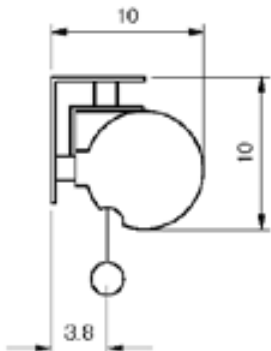

## SUPER GEAR PRO



Image format Ht x Base (cm)	Matt white Ref.	Casing length (cm)
<b>4:3 format</b>		
135 x 180	MPP08B1135180	190
150 x 200	MPP08B1150200	210
180 x 240	MPP08B1180240	250
<b>16:10 format</b>		
112 x 180	MPP08B1112180	190
125 x 200	MPP08B1125200	210
150 x 240	MPP08B1150240	250
<b>1:1 format</b>		
150 x 150	MPP08B1150150	160
180 x 180	MPP08B1180180	190
200 x 200	MPP08B1200200	210
230 x 230	MPP08B1230230	250

## STAND-OFF BRACKETS

The pair	Reference
10 cm	OPTECAR10
20 cm	OPTECAR20
30 cm	OPTECAR30
40 cm	OPTECAR40



- ANY HEIGHT STOP
- SLOW RETURN SYSTEM
- SLIDING BRACKETS

# ORAY 2000

The **ORAY 2000** is a manual screen with a white lacquered steel housing. It is equipped with a spring roller for silent operation.

- Wall or ceiling mounting brackets are integrated into the ends of the screen.
- It has a stop device on its whole height (approximately every 10 cm).



Photo credit: ORAY



White lacquered steel casing

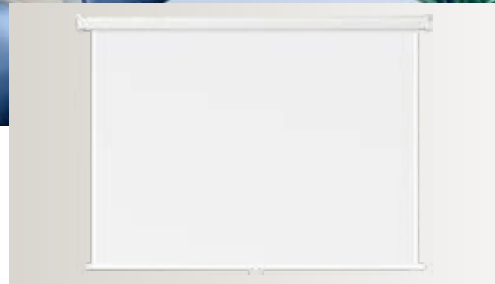

Oray 2000 PRO

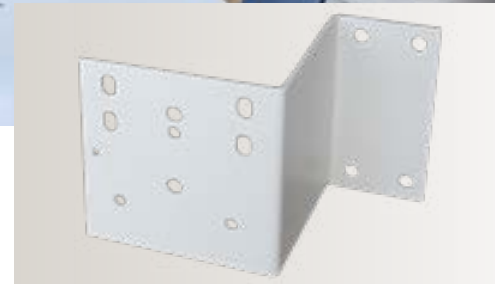

OPTION Stand-off brackets

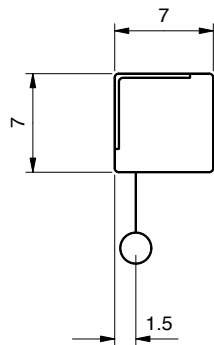

## ORAY 2000 PRO



Image format Ht x Base (cm)	Matt white Ref.	Casing length (cm)
<b>4:3 format</b>		
135 x 180	MPP03B1135180	193
150 x 200	MPP03B1150200	213
<b>16:10 format</b>		
112 x 180	MPP03B1112180	193
125 x 200	MPP03B1125200	213
150 x 240	MPP03B1150240	253
<b>1:1 format</b>		
150 x 150	MPP03B1150150	163
180 x 180	MPP03B1180180	193
200 x 200	MPP03B1200200	213

## STAND-OFF BRACKETS

The pair	Reference
10 cm	OPTECAR10
20 cm	OPTECAR20
30 cm	OPTECAR30
40 cm	OPTECAR40



- ECONOMIC
- ANY HEIGHT STOP





We present here a range both aesthetic and original, adapting to all your travelling constraints. Easy to set up, these screens are available in different formats.

## NOMADS

- Butterfly mobile p 19
- Fly p 20
- Dragonfly, Cross Screen, Miniscreen p 21
- Style, Byron 2, Screen p 22



# BUTTERFLY MOBILE

Ever more compact, the **BUTTERFLY MOBILE** is the fastest opening screen on the market. Ideal for rental or private use, up to 2m40 base.

- On both ends of the case of the screen, there is two large wheels that make it easy to carry around.
- The case design, fully made in aluminum, offers an efficient protection of the screen while carrying it around.
- Lift the top bar to open it instantly, thanks to the pantograph mechanism.



Wheels at the ends



Carrying handle



Pantograph mechanism

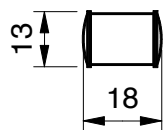

Large casing for 236cm base models

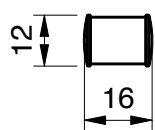

Small casing

## BUTTERFLY MOBILE



Image format Ht x Base (cm)	Black out Matt white	Casing Length (cm)
<b>4:3 format 2 cm black borders</b>		
117 x 156	BUT02B1120160	180
132 x 176	BUT02B1135180	200
147 x 196	BUT02B1150200	222
177 x 236	BUT02B1180240	262
<b>16:9 format 2 cm black borders + drop</b>		
110 x 196	BUT02B1112200	222
133 x 236	BUT02B1135240	262
<b>1:1 format 2 cm black borders</b>		
196 x 196	BUT02B1200200	222



- QUICK RELEASE
- WHEELS AT THE ENDS



# FLY

FLY is a generation of simple mobile screens, compacts and robusts.

Available in 2 versions:

- Fly Mono: Single front projection
- Green Fly : Green background for inlay

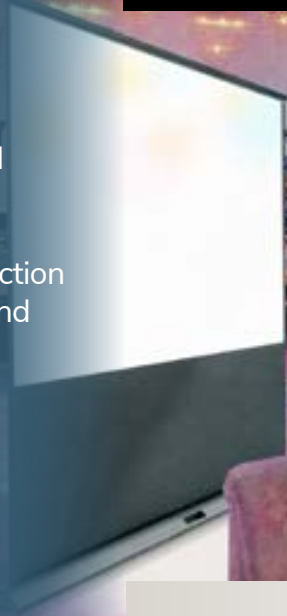

- The height is adjustable thanks to a telescopic upright and a tilting device ensures parallax compensation.
- A tensioning device has been specially designed to hold the screen surface taut and wrinkle free.
- The opaque projection surface bears black borders.
- Matt white screen gain: 1.1



Fly Mono



Green Fly



Telescopic upright

## FLY MONO



Single side front projection,  
black aluminum case.

Image format Ht x Base (cm)	Black out Matt white	 Casing Length (cm)
<b>16:10 format 2 cm black borders</b>		
97,5 x 156	FLY01B1100160	170
110 x 176	FLY01B1112180	190
122,5 x 196	FLY01B1125200	210

## GREEN FLY



Green background for inlay,  
black aluminum case.

Image format Ht x Base (cm)	Green fabric	 Casing length (cm)
<b>Special format</b>		
220 x 180	FLY01VV220180	190
220 x 200	FLY01VV220200	210



- DESIGN
- MULTI-FORMAT
- LIGHTWEIGHT



# DRAGONFLY CROSS SCREEN MINISCREEN

The **DRAGONFLY** at the tip of innovation represents the entire know-how of ORAY in terms of mobile screens.

The **MINISCREEN** is a portable screen, ultra-light, very easy to use specially developed for Picoprojectors, to be placed on a table.

The **CROSS SCREEN** is an ultraportable screen that gets easily and quickly assembled and disassembled while offering a wide projection surface.

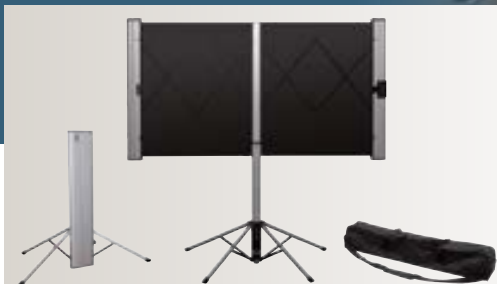

DRAGONFLY: Horizontal pantograph system



CROSS SCREEN: lightweight

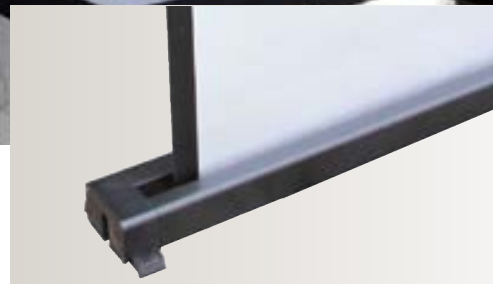

MINISCREEN Open feet

## DRAGONFLY



Multi-formats screen thanks to its pantograph system and horizontal opening.

- Easily carried around with its reinforced transport bag.
- Its 4-feet stand makes it very stable.
- The innovative horizontal opening offers a large screen that can fold back lengthwise, which reduces its bulkiness.

Image format Ht x Base (cm)	Black out Matt white Reference
<b>3 formats in 1: 4:3, 16:10 and 16:9</b>	
101 x 134/ 162 /180	DRA01B1101180

## CROSS SCREEN



With its transport bag, the CrossScreen is particularly adapted to nomadic presentations. Installed in a few minutes:

- Easy and very quick to set up
- Adjustable in height
- Can be fixed to the wall

Image format Ht x Base (cm)	Black out Matt white Reference
<b>16:9 format</b>	
75 x 133	CS1B1075133
87 x 155	CS1B1087155
100 x 177	CS1B1100177
112 x 200	CS1B1112200

## MINISCREEN



Ultra lightweight portable screen, very simple to set. It is dedicated to pico projectors and can be placed on a table.

- The black anodized aluminum housing combines lightness and quality.
- The fabric is tensioned thanks to an upright placed at the back of the casing.
- Easy to open in few seconds for your presentations to a wide audience in any circumstance.

Image format Ht x Base (cm)	Black out Matt white Reference
<b>4:3 format 2 cm side borders</b>	
79 x 102	MIN01B1079102

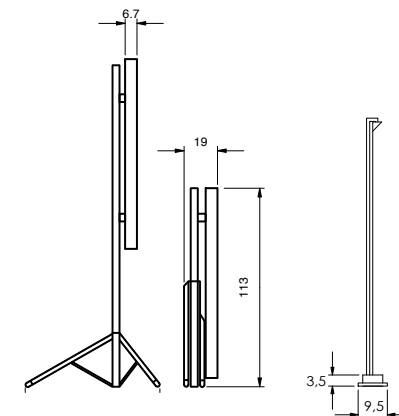

Dragonfly

Miniscreen



- TRANSPORT BAG
- COMPACT
- LIGHTWEIGHT



# STYLE BYRON2 SCREEN

Tripods remain the must-have products in the institutional market and general public. From the Style, the most robust tripod of the market, to the Screen more intended to personal use, this range meets your needs for mobility and resistance.

Very robust and extremely easy to use. They are the ideal compromise for all projections that just need temporary installation.



BYRON 2: White back  
SCREEN: Black back

STYLE 5 wheels foot

STYLE tripod



SCREEN Telescopic upright



OPTION Transport bag for tripods

## SCREEN



Small dimensions and easy to use, these screens are consumer-grade products. Black lacquered steel casing.

Image format Ht x Base (cm)	Black out Matt white Reference
<b>1:1 format</b>	
125 x 125	TRE03B1125125
150 x 150	TRE03B1150150
175 x 175	TRE03B1175175

## STYLE



White lacquered aluminium casing perfectly resistant to torsion.

- Supplied with a tiltable stem for parallax correction.
- Ultra robust handle.

Image format Ht x Base (cm)	Matt white tripod	Matt white wheels foot
<b>4:3 format</b>		
180 x 240	TRE06B1180240	
<b>1:1 format</b>		
150 x 150		PIE06B1150150
180 x 180		PIE06B1180180
200 x 200		PIE06B1200200
230 x 230	TRE06B1230230	

## BYRON 2



Black lacquered steel casing  
Fire resistant matt white projection surface (M1)

Image format Ht x Base (cm)	Matt white Reference
<b>1:1 format</b>	
150 x 150	TRE02B1150150
180 x 180	TRE02B1180180
200 x 200	TRE02B1200200

Reference	Casing length (cm)
HOUSV2BYR150	150
HOUSV2BYR180	180
HOUSV2BYR200	200
HOUSV2BYR240	240



- CLASSIC
- POWERFUL

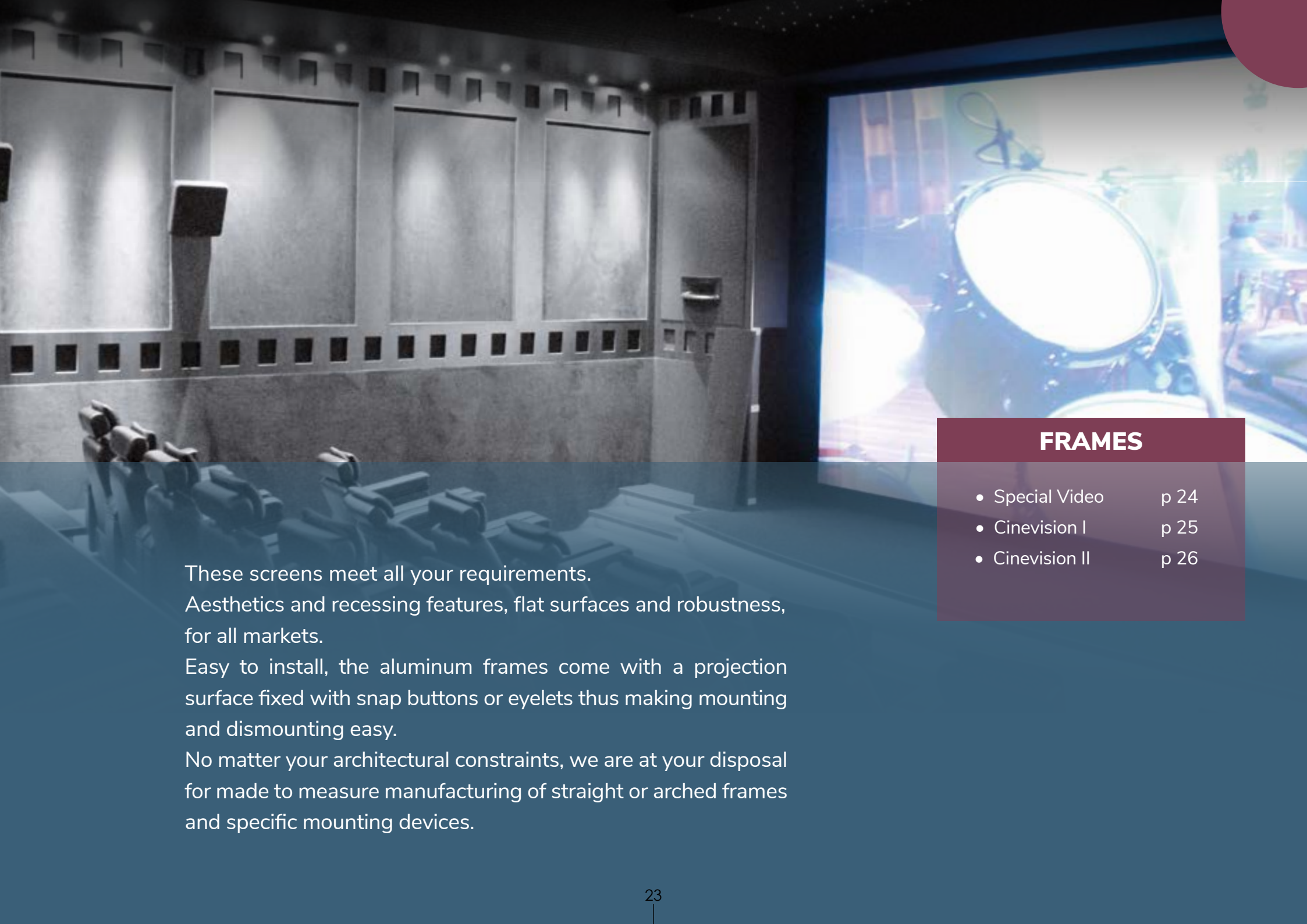

These screens meet all your requirements.

Aesthetics and recessing features, flat surfaces and robustness, for all markets.

Easy to install, the aluminum frames come with a projection surface fixed with snap buttons or eyelets thus making mounting and dismounting easy.

No matter your architectural constraints, we are at your disposal for made to measure manufacturing of straight or arched frames and specific mounting devices.

## FRAMES

- Special Video p 24
- Cinevision I p 25
- Cinevision II p 26



# SPECIAL VIDEO

The **SPECIAL VIDEO** is a discreet screen with a thin profile that leaves the focus to the projection. Easy to assemble, without tools!



- Rigid, design and easy to assemble,
- Avoids the projection of shadows on the image.
- The whole system can be assembled in a few minutes without any special tools. The frame is easily set up and locked automatically.
- The screen fabric is fixed at the back of the frame with snap buttons.



Black anodized



Profile of the frame



The screen fabric is fixed with snap buttons

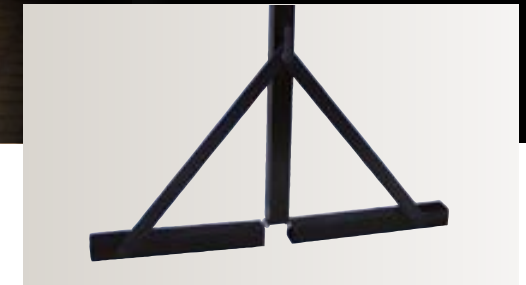

OPTION removable legs: Black anodized feet with parallax compensation.

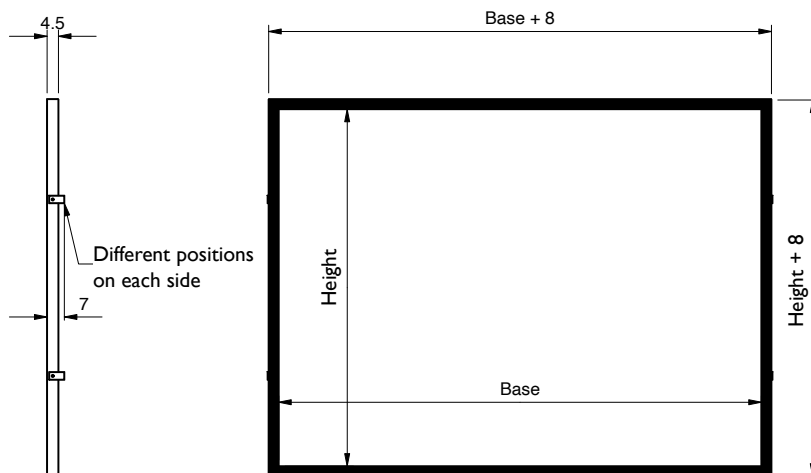

## SPECIAL VIDEO



Image format  
Ht x Base (cm)

Matt white  
Ref.



### 4:3 format

150 x 200	SP1B1150200
180 x 240	SP1B1180240
202 x 270	SP1B1202270
225 x 300	SP1B1225300
300 x 400	SP1B1300400

### 16:10 format

125 x 200	SP1B1125200
150 x 240	SP1B1150240
169 x 270	SP1B1169270
187 x 300	SP1B1187300
250 x 400	SP1B1250400

Other sizes, fabrics, colours, ON REQUEST



- THICKNESS
- LIGHTWEIGHT
- EASY

# CINEVISION I

CINEVISION I is designed for large projection surfaces and adaptable to all movie theaters, it will also suit large conference rooms, communication rooms, show rooms and auditoriums.



- Wall mount or suspended,
- Custom made,
- Available in all dimensions,
- Can be mounted and dismantled as wished,
- Can be fixed at a distance from the wall with optional stand-off brackets.

Millau Museum



The projection surface is tensioned with eyelets at the back of the frame.

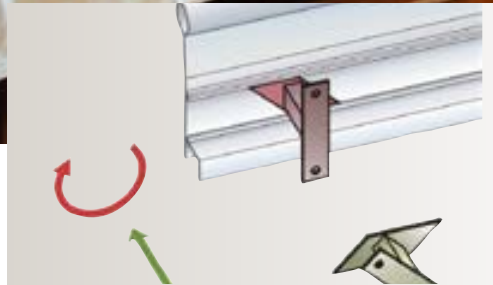

Quick suspension of the frame on its mounts and locking feature by 45° rotation



Millau Museum



## CINEVISION 1



Requested information to make a quote:

- Type of projection surface
- Image format
- Mount type

Quote on request according to your specs



- LIGHT WEIGHT
- LARGE SIZES

# CINEVISION II

CINEVISION II is a screen with a revolutionary lacing of the fabric and black velvet frame for your large sizes.

- Large aluminum profile for rigidity and masking of the fabric fixation.
- Tensioning device of the fabric easy to use.
- Wall mount or suspended,
- Custom made,
- Available in all dimensions,
- Black velvet frame width 21cm.



Shangri-La Hotel Beijing - China

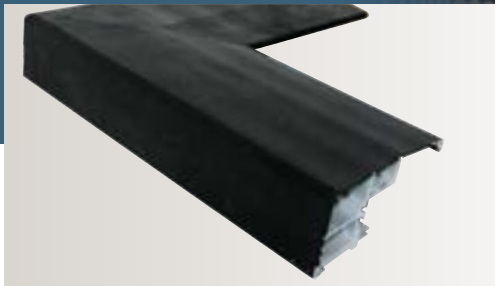

Aluminum frame covered with black velvet



Screen surface tensioning system.

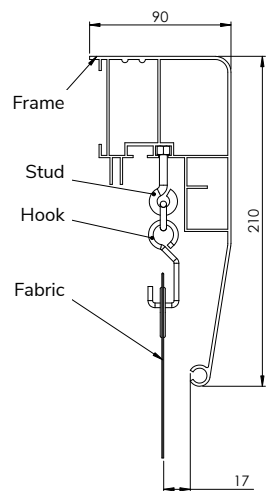

## CINEVISION II



Information required to perform a quotation:

- Type of projection surface
- Image format
- Mounting method

Quote on request according to your specs



- RIGIDITY
- AESTHETICS



Oray manufactures made-to-measure cyclos and special projection surfaces with a wide choice of finishes: eyelet, open hem, snap button, etc.

## CUSTOM-MADE FABRICS

- Projection surfaces p 28
- Finishes p 29

# PROJECTION SURFACES

The FRONT PROJECTION surfaces are made of recyclable PVC.

They can be perforated (acoustic surfaces), or 3D for special applications.

For REAR PROJECTION, surfaces are translucent to allow projection from behind the screen.



Installation © CSGV

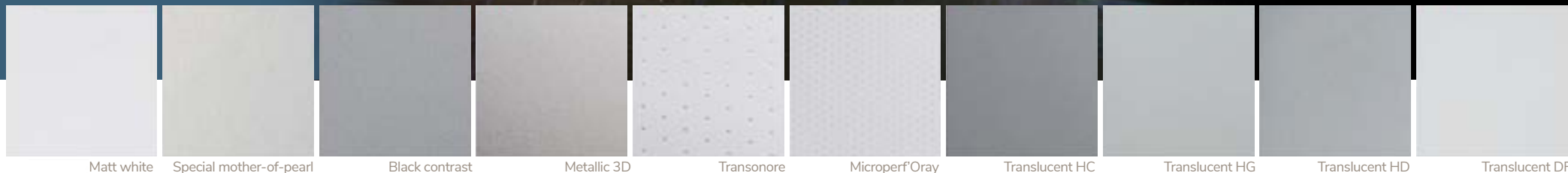

Matt white

Special mother-of-pearl

Black contrast

Metallic 3D

Transonore

Microperf'Oray

Translucent HC

Translucent HG

Translucent HD

Translucent DF

## NEW



You'll find some of our projection surfaces in their woodsense version, made from up to 92% natural ingredients and 100% recyclable.

- Classified b-s1,d0
- Reduced carbon footprint

### FRONT PROJECTION

- Matt white
- Black out Matt white
- Transonore
- Microperf'Oray
- Microperf'Oray HD 4K
- Special mother-of-pearl
- Metallic 3D
- Black contrast

### REAR PROJECTION

- Translucent HC
- Translucent HG
- Translucent HD
- Translucent DF
- Translucent 3D

### ADHESIVE FILM

- Window displays
  - Digital signage
  - Projection films
  - Holographic ...
- The widest and most specialised range of projection films on the market.



- CUSTOMIZED
- FINISHES



# FINISHES



Installation © Nakajima 中島良平



Snap button



Snap buttons on white borders



Eyelet



Open hem

## CONFECTION and KNOW-HOW

ORAY offers a wide range of confections for your made-to-measure projects: snap buttons, eyelets, open hems, round fabrics, etc.

## WIDE-WIDTH HD PRINTING

ORAY customises your fabrics by printing them with a logo, text or image on part or all of the surface.



- CUSTOMIZED
- FINISHES

See all our surfaces in detail at [www.oray.fr](http://www.oray.fr)



Our range of motorised mounts for video projectors offers integration solutions for all your installations.

A wide range of fixed mounts for video projectors and flat screens allows to adapt to all your constraints.

## MOUNTS

### For Video projectors

- Motorised mounts p 31
- Fixed ceiling mounts p 33
- Fixed wall mounts p 33
- Outdoor housing p 33

### For flat screens

- Fixed mounts p 34

# MOTORISED MOUNTS for VIDEO PROJECTORS

Our range of mounts is adapted to all kinds of integration to hide your video projector in the false ceiling.



Radio remote control supplied with Mini pantographe 10 and 20



Mini pantographe 10



Mini pantographe 20

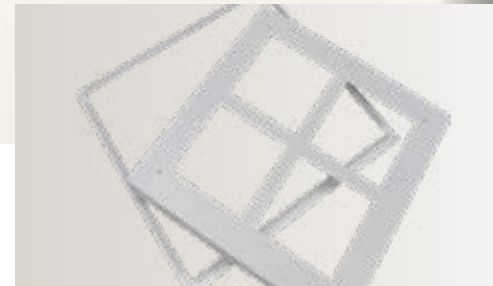

Recessed installation frame supplied with the mini pantographe 10

- Maximum run length: 80 cm
- Maximum load: 10 kg

**Supplied with:**

- Radio remote control (receiver equipped with up/ down buttons)
- Recessed installation frame.

**MINI-PANTOGRAPH 10**



Reference	Run length
SVP0801	80 cm

- Maximum run length: 195 cm
- Maximum load: 25 kg

**Supplied with:**

- Radio remote control (receiver equipped with up/ down buttons)

**MINI-PANTOGRAPH 20**



Reference	Run length
SVP0601	97,5 cm
SVP0602	195,0 cm

**Options**

SVPMOPT01 Recessed installation frame.



- INTEGRATION
- FINISHING

# MOTORISED MOUNTS for VIDEO PROJECTORS

Pantographs and mirror mounts perfectly integrate the video projectors inside false ceilings.



Radio remote control for mirror mount

Mirror mount installed in false ceiling



Mini pantographe 30

30 kg  
maxi

- Maximum run length: 400 cm
- Maximum load: 30 kg

**Supplied with:**

- Radio remote control



Pantographe 100

100 kg  
maxi

- Maximum run length: 400 cm
- Maximum load: 100 kg

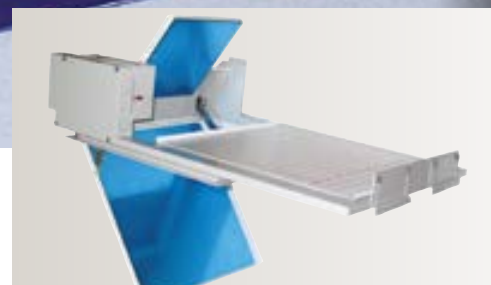

Mirror mount

- Perfect integration
- Invisibility
- Small bulk

**Supplied with:**

- Radio remote control



Invisibility of the mirror mount with the frame+cover kit

**MINI PANTOGRAPHE 30**



Reference	Run length
SVP0501	100 cm
SVP0502	200 cm
SVP0503	300 cm
SVP0504	400 cm
Options	
SVP0PTPAT01	Recessed plate brackets

**PANTOGRAPHE 100**



Reference	Run length
SVP0401	100 cm
SVP0402	200 cm
SVP0403	300 cm
SVP0404	400 cm

**MIRROR MOUNT**



Reference	SVPM001
Options	
SVPM0PT03	Package Frame+Cover



- INTEGRATION
- FINISHING



# FIXED MOUNTS for VIDEO PROJECTORS

For more products,  
please contact us

## FIXED CEILING MOUNTS

- Independent adjustment of rotation, tilt and horizontal position
- Maximum load 15 kg
- Available in silver, black or white
- Suitable for most video projectors mounted in reverse position
- Possibility to align image axis to the fixing axis.

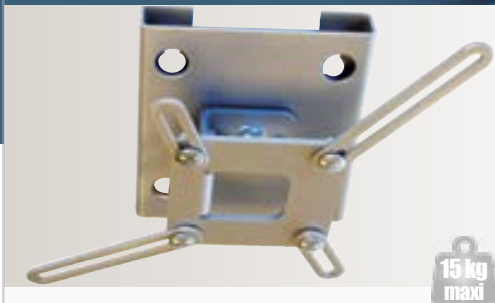

Short brackets: fixed ceiling mounts

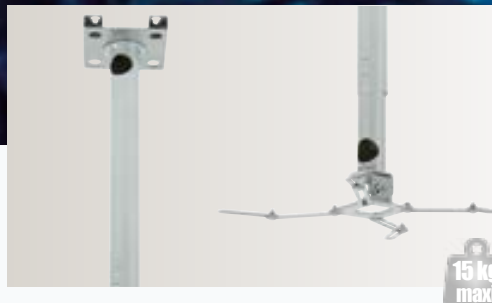

Long brackets: fixed ceiling mount

## FIXED CEILING MOUNTS (universal mount)

### SHORT BRACKETS

- Direct ceiling mounting

### LONG BRACKETS

#### With cable inlay system:

- From 7 cm to 90 cm for SVP005 brackets which can be cut.
- From 7 cm to 150 cm for SVP006 brackets which can be cut.

Reference	Brackets description	Colors
SVP002A	Short	Black
SVP002S	Short	Silver
SVP002B	Short	White
SVP005A	Adjustable (7 to 90 cm)	Black
SVP005S	Adjustable (7 to 90 cm)	Silver
SVP005B	Adjustable (7 to 90 cm)	White
SVP006A	Adjustable (7 to 150 cm)	Black
SVP006S	Adjustable (7 to 150 cm)	Silver
SVP006B	Adjustable (7 to 150 cm)	White



Wall mount SVP0010

## WALL MOUNTS FOR SHORT THROW PROJECTORS

To be fixed above the screen or the interactive board.

Mounting plate with independent tilting and horizontality adjustments.

- Steel structure
- Maximum load 15 kg

Reference	Description
SVP0010	Short throw VP mount adjustable 75-135 cm

## OUTDOOR HOUSING

Extreme protection for high power video projectors whatever the climate constraints are.

- 5 standard dimensions
- Custom-made on request



Outdoor housing

## OUTDOOR HOUSING

- Tilting
- Made in fibreglass
- IP 54
- Patented product
- Antitheft with several locks
- Heating and ventilation system
- Swiveling when the mounting is made with a central screw on the base (standard)
- Control via a smartphone or PC thanks to an app with bluetooth
- Single-phase socket of 16 Amp (3,5KWatt) except for the XXL reference 32 Amp (7KWatt))

# WALL MOUNTS for FLAT SCREENS

For more products,  
please contact us



## WALL MOUNTS VESA FROM 75 TO 600 X 400



### FIXED

- Ultra slim: 20mm from wall
- Level check for easy installation

Reference	Description	Max. load.
SPL030	Vesa 100	15 kg
SPL031	Vesa 200	30 kg
SPL032	Vesa 400	30 kg
SPL033	Vesa 600	30 kg

### TILTING

- Tilting: +5/-15°
- Level check for easy installation

Reference	Description	Max. load
SPL034	Vesa 100	15 kg
SPL035	Vesa 200	30 kg
SPL036	Vesa 400	30 kg
SPL037	Vesa 600	30 kg



### TILTING AND PIVOTING

- Tilting: +5/-15°
- Twist: see board hereunder
- Level check for easy installation

Reference	Description	Offset	tilting pivoting	Charge max.
SPL038	Vesa 100TW45	99mm	+25°/-25°	15 kg
SPL039	Vesa 200TW45	99mm	+20°/-20°	30 kg
SPL040	Vesa 400TW45	255mm	+40°/-40°	30 kg
SPL041	Vesa 100TW90	244mm	+65°/-65°	15 kg
SPL042	Vesa 200TW90	255mm	+60°/-60°	30 kg
SPL043	Vesa 400TW90	375mm	+65°/-65°	30 kg



Ref.: SPL025, 26, 27

### UNIVERSAL MOUNTS FOR LARGE SIZE FLAT SCREENS: Ultra thin, for LED screens

#### SPL025, 26 and 27

- Extra-flat: the screen is as close to the wall as possible: 16 mm
- Steel wall plate and screen mount.
- Eccentric washer system to correct drilling errors
- Anti-tear system of the screen
- Built-in spirit level - Allows you to check the horizontality of the support when drilling

Reference	Fixation	Offset	Max. load
SPL025	Vesa 75-200	16mm	50kg
SPL026	Vesa 200-400	16mm	60kg
SPL027	Vesa 200-600	16mm	70kg



Ref.: SPL028

#### SPL028 and 29

- Steel wall plate and screen support
- Eccentric washer system to correct drilling errors
- Anti-tear system of the screen
- Tilttable 0°-25°
- Level check for easy installation

Reference	Fixation	Orientation	Max. load
SPL028	Vesa 200 - 400	non	30 kg
SPL029	Vesa 200 - 400	+ / - 90°	30 kg



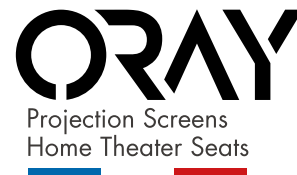

**ORAY**  
Chemin de Beaurepaire  
91410 DOURDAN - FRANCE  
Tel +33 (0)1 64 59 94 54  
[www.oray.fr](http://www.oray.fr)